

## Wiring Diagram: Rex A-4 with Spider W5

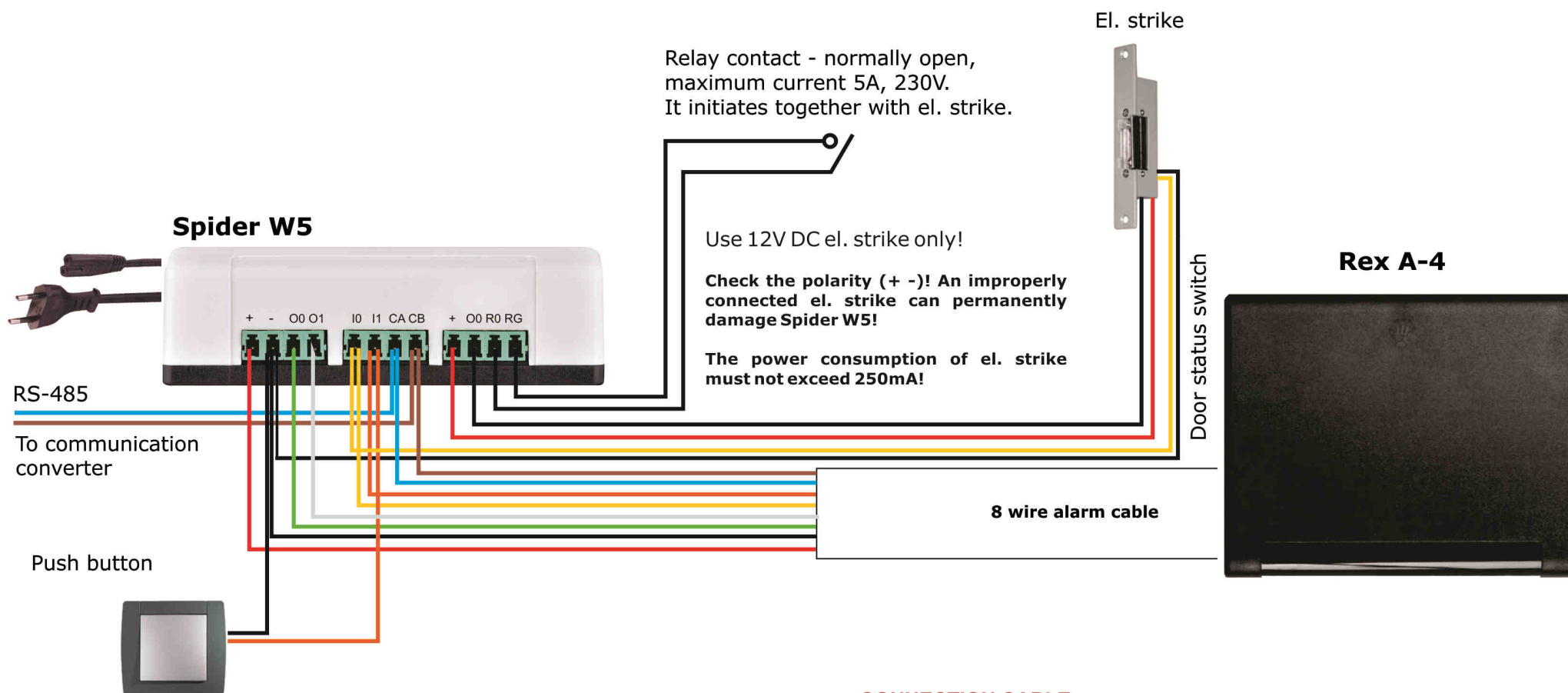

Connect Rex to the Spider W5 power supply as shown in the diagram with a standard UTP cable.

For distances greater than 25m, use one twisted pair of UTP cable for each pole ( + and -).

The cable length between the power supply and the Rex should not exceed 50m. Connect the Spider W5 to the mains power 110-230V AC with the enclosed power cord.

### CONNECTION CABLE

Wire	Colour	Description	Spider Connector
1	Red	9-14V DC	+
2	Gray/Black	GND	-
3	Green	El. strike output	O0
4	White	Not connected	O1
5	Yellow	Door switch input	I0
6	Orange	Push button input	I1
7	Blue	RS-485 CA	CA
8	Brown	RS-485 CB	CB

